

AME 3623 Real-Time Embedded Systems
Final Exam
May 8, 2019

General instructions:

- Please wait to open this exam booklet until you are told to do so.
- This examination booklet has 14 pages. You also have been issued a bubble sheet.
- Write your name, university ID number and date, and sign your name below. Also, write your name and ID number on your bubble sheet, and fill in the bubbles for your ID.
- The exam is closed book, notes and electronic devices. The exception is that you may have one page of personal notes (double sided).
- The exam is worth a total of 274 points (and 20% of your final grade).
- You have 2 hours to complete the exam. Be a smart test taker: if you get stuck on one problem, go on to the next.
- Use your bubble sheet to answer all multiple-choice questions. Make sure that the question number and the bubble row number match when you are answering each question.

On my honor, I affirm that I have neither given nor received inappropriate aid in the completion of this exam.

Signature: _____ **Name:** _____

ID Number: _____ **Date:** _____

Question	Points	Score
Number Representations and Operations	45	
Circuits	48	
Circuits and Code	46	
Control	24	
Interrupt Service Routines	29	
Serial Processing	13	
Digital-Analog Systems	28	
Finite State Machines	41	
Total:	274	

Part I. Number Representations and Operations

1. (6 points) What is the hexadecimal value of c after the following code is executed?

```
uint8_t a = 0x27;  
uint8_t b = 0x12;  
uint8_t c = (a & 27) | b;
```

- A. 0x12 **B. 0x13** C. 0x27 D. 0x37 E. Answer not shown

2. (5 points) What is the binary representation of a after the following code is executed?

```
uint8_t a = 0xA2;
```

- A. 1010 0010** B. 1010 0100 C. 1100 0010 D. 1100 0100
E. Answer not shown

3. (6 points) What is the representation of $5\frac{1}{8}$ using “12.4” fixed-point? Give your answer in hexadecimal.

- A. 0x0029 B. 0x002A C. 0x0051 **D. 0x0052** E. Answer not shown

4. (6 points) What is the hexadecimal value of c after the following code is executed? Assume a “4.4” fixed-point representation.

```
uint8_t a = 0x33;  
uint8_t b = 0x21;  
uint8_t c = fixed_point_add(a, b);
```

- A. 0x05 B. 0x40 **C. 0x54** D. 0x540 E. Answer not shown

5. (6 points) What is the hexadecimal value of c after the following code is executed? Assume a “6.2” fixed-point representation.

```
uint8_t a = 0x23;  
uint8_t b = 0x2;  
uint8_t c = fixed_point_multiply(a, b);
```

- A. 0x11** B. 0x18 C. 0x46 D. 0x118 E. Answer not shown

6. (6 points) What is the decimal value of b after the following code is executed?

```
uint8_t a = 8;
uint8_t b = 7 * (a / 10);
```

- A. 4 B. 5 C. 5.6 D. 6 **E. Answer not shown**
7. (5 points) What is the range of values that are representable by a signed, 4-bit integer?
- A. [0 ... 7] B. [0 ... 15] **C. [-8 ... 7]** D. [-16 ... 15]
E. Answer not shown
8. (5 points) What is the binary representation for -42? Assume a signed, 8-bit integer.
- A. 0010 1010 B. 0100 0010 C. 1101 0101 **D. 1101 0110**
E. Answer not shown

Part II. Circuits

Consider the following circuit:

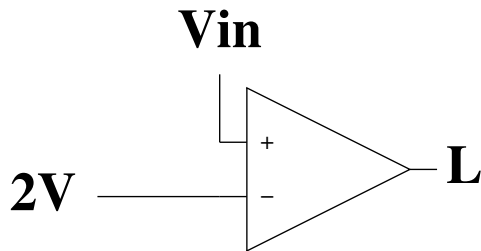

Assume that L is a logical value.

9. (5 points) If $V_{in} = 6.5 V$, what is L ?
 A. True B. False C. Answer not shown
10. (5 points) If $V_{in} = 2.5 V$, what is L ?
 A. True B. False C. Answer not shown

Consider the following circuit:

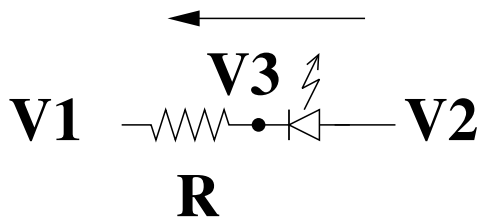

Assume that $V_f = 1V$ and $R = 100\Omega$.

11. (8 points) If $V_1 = 2V$ and $V_2 = 5V$, what is V_3 ?
 A. $2 V$ B. $3 V$ C. $4 V$ D. $5 V$ E. Answer not shown
12. (8 points) If $I_D = 20 mA$, $V_3 = 10 V$, what is V_1 ?
 A. $8 V$ B. $9 V$ C. $10 V$ D. $11 V$ E. Answer not shown

Consider the following circuit:

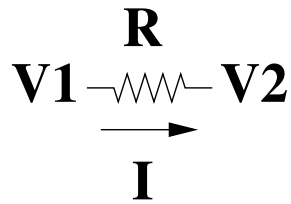

13. (7 points) Given $R = 500\Omega$, $V_1 = 7V$ and $V_2 = 3V$. What is I ?
A. 4 mA B. 8 mA C. 14 mA D. 18 mA E. Answer not shown
14. (7 points) Given $R = 250\Omega$, $V_1 = 6V$ and $I = 10\text{ mA}$. What is V_2 ?
A. -2.5 V B. 2.5 V C. 3.5 V D. 8.5 V E. Answer not shown

Consider the following circuit:

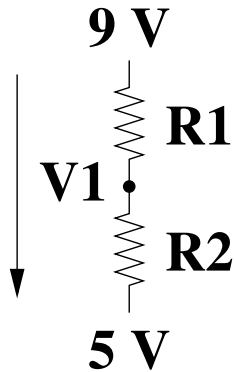

15. (8 points) Assume that $R_1 = 300\Omega$ and $R_2 = 100\Omega$. What is V_1 ?
A. 1 V B. 3 V C. 6 V D. 8 V E. Answer not shown

Part III. Circuits and Code

Consider the following circuit:

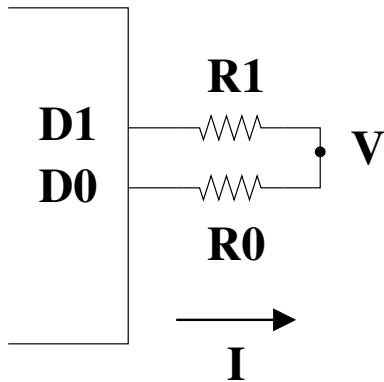

Assume $R_0 = 50\Omega$, $R_1 = 150\Omega$ and the maximum voltage output by a microprocessor pin is $5V$. Also assume that D0/D1 have been configured as output pins.

16. (8 points) If $PORTD_PDOR = 0x00$, what is V ?
A. $0V$ B. $1.25V$ C. $2.5V$ D. $3.75V$ E. Answer not shown
17. (8 points) If $PORTD_PDOR = 0x2$, what is V ?
A. $0V$ B. $1.25V$ C. $2.5V$ D. $3.75V$ E. Answer not shown

Consider the following circuit and associated function:

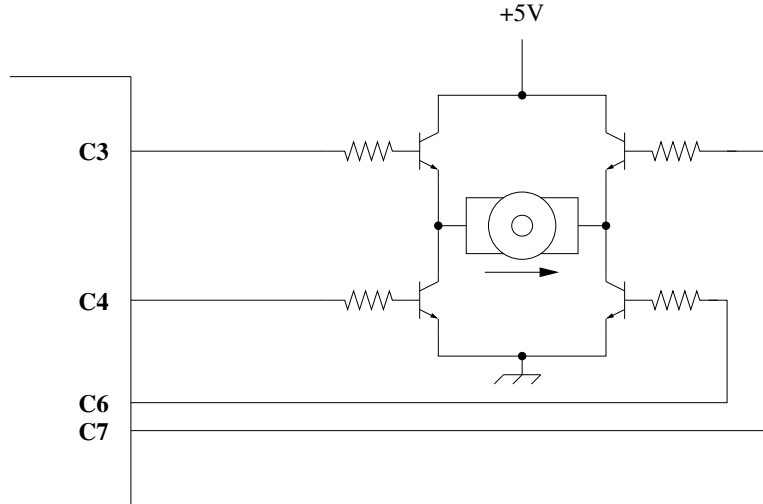

```
int control (uint32_t mask, uint32_t count)
{
    for(int i = 0; i < count; ++i)
    {
        GPIOC_PDOR = 0;
        delay(3);
        GPIOC_PDOR = mask;
        delay(1);
    }
}
```

Assume that the motor can be modeled as a 1Ω resistor and that positive current flow is indicated by the arrow.

18. (6 points) What is the correct initialization for GPIOC_PDDR?
 - A. 0xF
 - B. 0x64
 - C. 0x68
 - D. 0xD8**
 - E. Answer not shown
19. (8 points) When control(0x4F, 1000) is called, at what duty cycle is the motor being driven?
 - A. 0%
 - B. 25%**
 - C. 50%
 - D. 100%
 - E. Answer not shown
20. (8 points) When control(0x71, 1000) is called, at what duty cycle is the motor being driven?
 - A. 0%**
 - B. 25%
 - C. 50%
 - D. 100%
 - E. Answer not shown
21. (8 points) When control(0x95, 1000) is called, what is the average current through the motor while the function is executing?
 - A. -5 A
 - B. -1.25 A**
 - C. 1.25 A
 - D. 5 A
 - E. Answer not shown

Part IV. Control

Consider the following P-D control law for lateral control of your hovercraft:

$$f_x = K_{lp}(x_d - x) + K_{lv}(\dot{x}_d - \dot{x})$$

$$f_y = K_{lp}(y_d - y) + K_{lv}(\dot{y}_d - \dot{y})$$

where x , y , \dot{x} and \dot{y} are the sensed state of the hovercraft.

Assume that positive positions and forces are forward for the X direction and to the left for the Y direction.

22. (6 points) In order to achieve critical damping, what is the sign of K_{lp} ?
A. $K_{lp} > 0$ B. $K_{lp} < 0$
23. (6 points) The x_d term in the control equation can best be described physically as:
A. a spring B. a velocity **C. a position** D. friction
E. Answer not shown
24. (6 points) Suppose that the hovercraft oscillates around the goal position. Assuming that we keep K_{lp} constant, how should we change K_{lv} ?
A. Decrease it B. No change **C. Increase it**
25. (6 points) Which of the following is always true with respect to your project 8, 9 and 10 implementations?
A. $K_{lp} = 0$ B. $K_{lv} = 0$ C. $\dot{x} = 0$ D. $\dot{x}_d = 0$ E. Answer not shown

Part V. Interrupt Service Routines

Consider the following code:

```
volatile uint8_t a = 1;
volatile uint8_t b = 1;

void myISR() {
    static uint8_t c = 0;

    ++c;
    if(c == b) {           // equal
        c = 0;
    }

    if(c == 0) {         // equal
        GPIOD_PDOR |= 0x40; // OR equal
    }

    if(c == a) {         // equal
        GPIOD_PDOR &= ~0x40; // AND equal not
    }
}

int setup() {
    // Configure PORTD, bit 6 to be digital I/O
    PORTD_PCR6 = PORT_PCR_MUX(0x1);
    // Configure bit 6 to be an output
    GPIOD_PDDR = 0x40;

    // Configure the timer
    Timer1.initialize(1000);
    Timer1.attachInterrupt(myISR);
    Timer1.start();
}

loop() {
}
```

26. (5 points) True or false: this is an example of an external interrupt.
A. True **B. False**

27. (8 points) What is the interrupt frequency?
A. 10 Hz B. 100 Hz C. 1,000 Hz D. 10,000 Hz E. Answer not shown

28. (8 points) When $a = 5$ and $b = 20$, what is the frequency of the signal at PORT D, pin 6?
A. 4 Hz B. 50 Hz C. 200 Hz D. 1,000 Hz E. Answer not shown

29. (8 points) When $a = 10$ and $b = 50$, what is the duty cycle of the signal at PORT D, pin 6?
A. 0% B. 20% C. 50% D. 100% E. Answer not shown

Part VI. Serial Processing

The following function is to change upper case letters to lower case and lower case letters to upper case, and otherwise leave the character unchanged:

```
1  char flip_case(char c)
2  {
3      if(c >= 'a' && c <= 'z')
4      {
5          c = c - 'a' + 'A';
6      }
7      else if(c >= 'A' && c <= 'Z')
8      {
9          c = c + 'A' - 'a';
10     }
11     return (c);
12 }
```

30. (8 points) On which line is the bug?
A. 3 B. 5 C. 7 **D. 9** E. Answer not shown
31. (5 points) True or False: a shared clock is used in a synchronous serial protocol.
A. True B. False

Part VII. Digital-Analog Systems

32. (6 points) Of the analog-to-digital conversion approaches that we studied, which takes the shortest period of time to complete the conversion?
A. Flash Analog-to-Digital Conversion B. Successive Approximation
C. They are equal
33. (6 points) Assume a 4-bit digital-to-analog converter with a range of 0 to 5 volts. What is the resolution of the converter?
A. $1/51 V$ B. $1/15 V$ **C. $1/3 V$** D. $5 V$ E. Answer not shown
34. (8 points) Assume an 8-bit digital-to-analog converter with a range of 0 to 5 volts. What voltage corresponds to a digital value of 102?
A. $2/255 V$ B. $2/15 V$ C. $2/5 V$ **D. $2 V$** E. Answer not shown
35. (8 points) Assume an 8-bit analog-to-digital converter that uses the successive approximation algorithm, and has a range of 0 to 5 volts. If $V_{in} = 1 V$ and the first guess by successive approximation is 1000 0000, what is the fifth guess?
A. 0011 0010 B. 0011 0011 C. 0011 0100
D. 0011 1000 E. Answer not shown

Part VIII. Finite State Machines

Consider the following block of code that implements part of a FSM that controls our hovercraft. This part is to move forward until a wall is detected, make a turn, and then continue moving forward.

Assume that all global variables are already defined.

```
1  static State state = A;
2
3  switch(state)
4  {
5      case A:
6          fan.write(80);
7          desired_velocity[0] = .2;
8          desired_velocity[1] = 0;
9          state = B;
10         break;
11
12         case B:
13             if(distance_front > .4)
14             {
15                 desired_velocity[0] = 0;
16                 desired_velocity[1] = 0;
17                 state = C;
18                 counter = 0;
19             }
20             break;
21
22         case C:
23             counter++;
24             if(counter > 100)
25             {
26                 heading_goal = heading_goal + 90.0;
27                 if(heading_goal > 180.0)
28                     heading_goal -= 360.0;
29                 state = D;
30             }
31             break;
32
33         case D:
34             if(heading_error < -DB || heading_error > DB)
35             {
36                 desired_velocity[0] = .2;
37                 desired_velocity[1] = 0;
38                 state = E;
39             }
40             break;
41         :
42     }
```

36. (8 points) Which of the following lines of code has a bug?
A. 7 B. 9 **C. 13** D. 17 E. These lines are bug-free
37. (8 points) Which of the following lines of code has a bug?
A. 23 B. 27 C. 28 **D. 34** E. These lines are bug-free

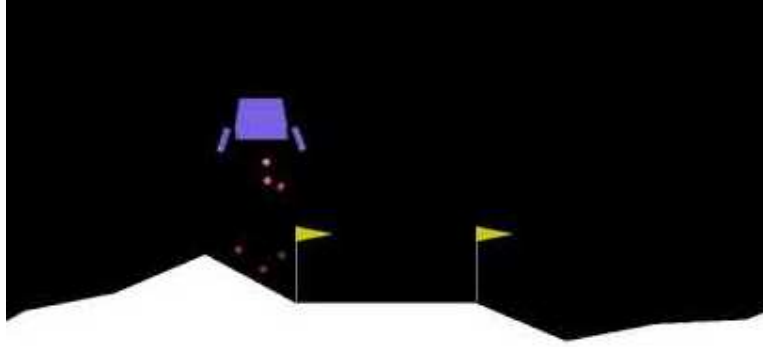

38. (25 points) You are designing a Finite State Machine to land a craft on the surface of the moon. The rules are:

1. The craft must land between the two flags at a horizontal speed (\dot{x}) no more than V_x and a vertical speed (\dot{z}) no more than V_z .
2. The horizontal positions of the left and right flags are X_L and X_R , respectively.
3. Positive X is to the right; positive Z is up. Orientation is not a concern.
4. Assume inertia is small relative to the capabilities of the thrusters.
5. Assume that the initial z is high relative to the flags.
6. The landing process must happen in the following phases:
 - (a) Stabilize vertical velocity
 - (b) Move between the flags
 - (c) Stabilize horizontal velocity
 - (d) Landed

Once one phase is complete, you may assume that its conditions will then be satisfied for the duration of the landing procedure. For example, once the vertical velocity of the craft is stabilized, then this will be true until landing.

The events are as follows:

- $x < X_L$
- $x > X_R$
- $\dot{x} > V_x$
- $\dot{x} < -V_x$
- $\dot{z} < -V_z$
- $z == 0$

Note that you may take the “not” of any event, too.

The actions are as follows:

- Accelerate left briefly (L)
- Accelerate right briefly (R)
- Accelerate up briefly (U)
- No thrust (X)

Draw the Finite State Machine that controls the craft.

Solution: ***